

Portata/Lifting capacity (Kg)	40
A (mm)	240x240
B (mm)	900x300x10
h (mm)	450
H (mm)	720
t (mm)	Ø 60
T (mm)	Ø 80
Peso / Weight (Kg)	19

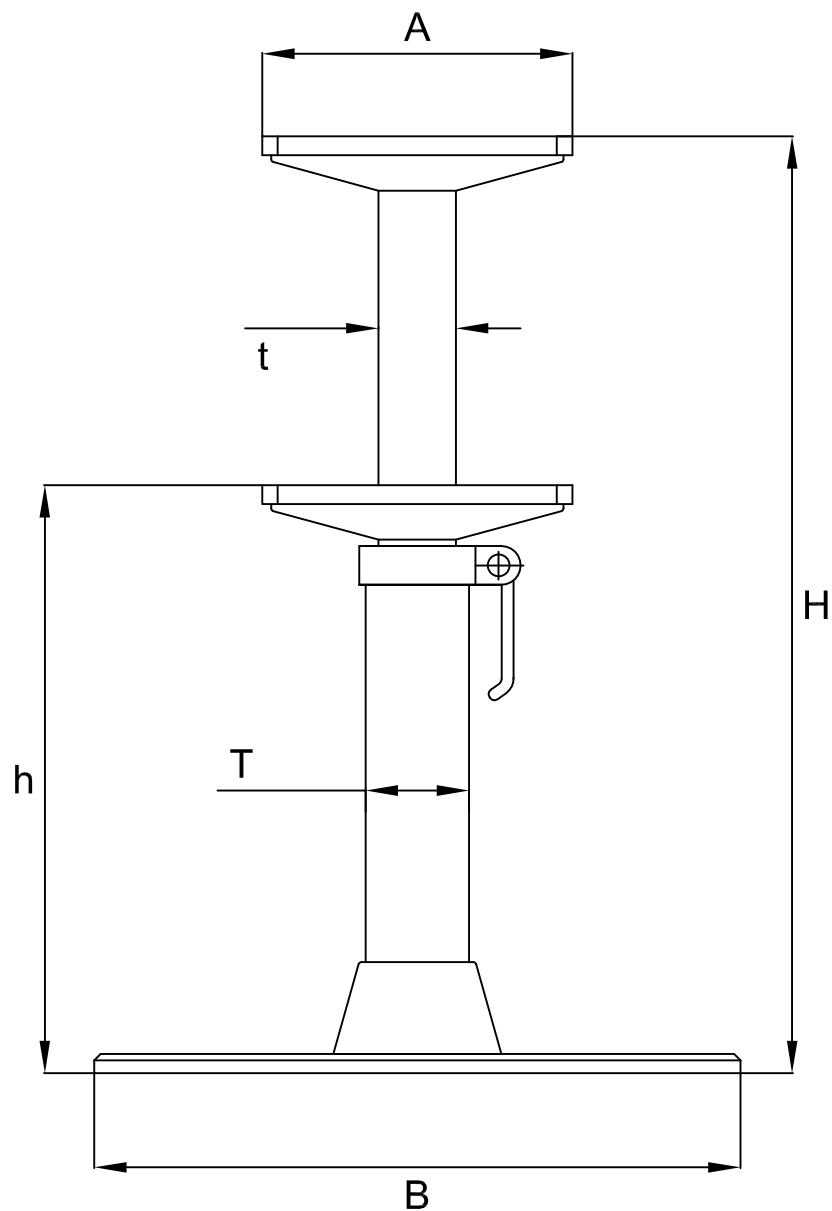

b[®] besenzoni
ITALY

Codice / Code

T 138 MG

Supporto tavolo manuale
Manual table pedestal