

Lifting capacity (Kg)	1200
A (mm)	4200
B (mm)	3090
G (°)	180 or 270
H (mm)	900
K (mm)	1400
L (mm)	3730
N (mm)	600
P (mm)	5000
Q (mm)	3290
R (mm)	1700
S (mm)	910
T (mm)	640
W (mm)	560
Weight (Kg)	450

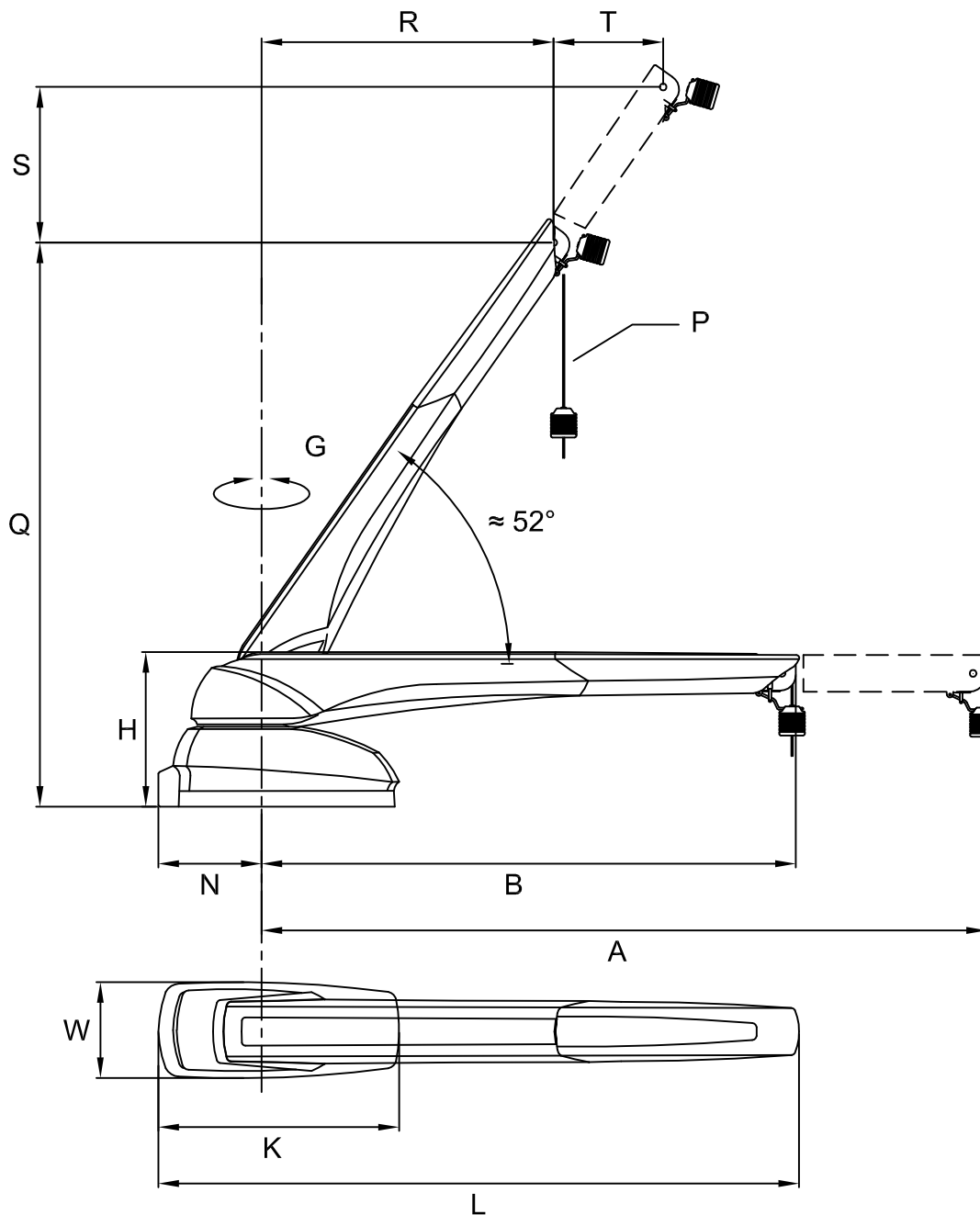

Product

G 432

Hydraulic Crane